

***BowlersJournal***  
INTERNATIONAL

---

**39<sup>TH</sup> BJI**

**BALL  
GUIDE**

---

**SUMMARIES AND STATS FOR 88  
BOWLING BALLS REVIEWED IN 2022**

---

For more than three-and-a-half decades, *Bowlers Journal International* has been reviewing bowling balls to help readers select the equipment that best matches their games and the lane conditions they encounter in league and tournament play. The pages that follow include summaries of all ball reviews written by “No Holes Barred” columnist Vernon Peterson during 2022 — 88 reviews in all.

The BJI Ball Guide was an annual event in the pages of *Bowlers Journal* for 37 consecutive years before taking a hiatus around the time of this magazine’s redesign with the January 2022 issue. Its return, now exclusively in digital form, once again accompanies the dawn of a new year as it had for decades because, to put it simply, we heard you. The BJI Ball Guide was missed by plenty of loyal readers of this magazine who expressed their yearning for its return and, in some cases, their suggestions for how to do it differently, and better, for the new era this magazine ushered with our January 2022 issue. To that end, in addition to publishing digital versions of the BJI Ball Guide in forthcoming years, we also are making available digital versions of the BJI Ball Guide from previous years. In this case, the 2022 BJI Ball Guide.

We believe the clean, efficient, and easily searchable experience this digital edition of the BJI Ball Guide provides will be a welcome new twist on an old tradition for *Bowlers Journal* readers both new and longstanding. The capsule reviews themselves include more statistical and manufacturing detail than prior editions of the BJI Ball Guide tended to present, and the succinct summaries of each of the 88 bowling balls reviewed here cut right to the chase of Peterson’s experience testing each with fellow reviewer Stephen DeLong.

While a short “snapshot” of each 2022 ball review appears in the forthcoming pages, we highly recommend reading the full reviews that appeared in “No Holes Barred” to gain a clearer understanding of the balls, their capabilities and their recommended uses. The original review month is included with each listing.

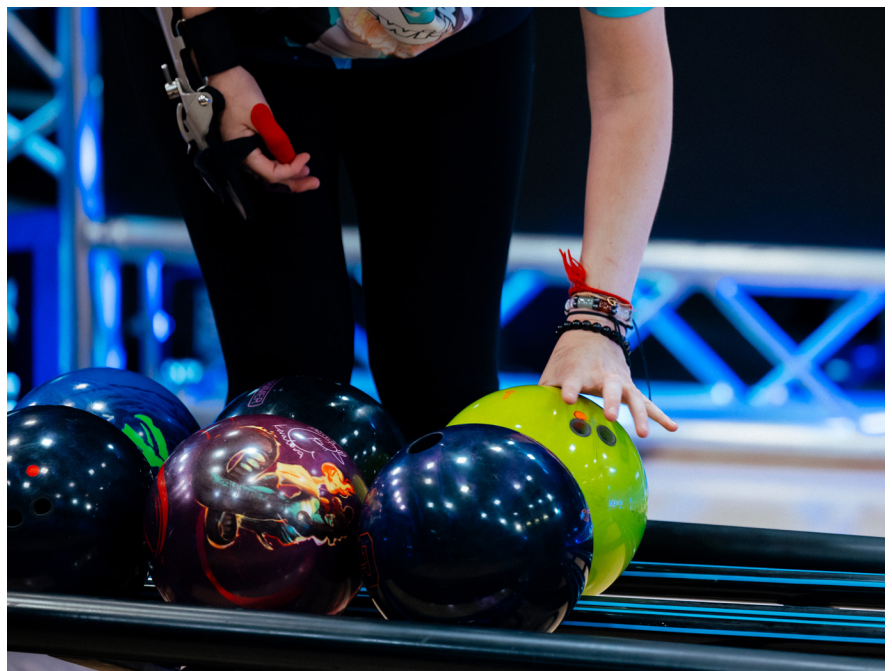

# Understanding the Ratings

## HOOK POTENTIAL

### 35-45

Balls with lower total hook ranges, best suited for lighter oil concentrations. Players with slower speeds or higher rev rates may also prefer balls in this range for medium oil applications.

### 45-51

Balls with medium hook ability, best suited for the vast majority of “typical house shots” and some lower-volume sport patterns. This hook range should be represented by the “center-piece” ball in most arsenals.

### 51-60+

Balls with greater total hook, designed for heavier oil volumes. Players with higher speeds or lower rev rates, who need added lane traction, may also prefer balls in this range.

## LENGTH RATINGS

### 8-12

Earlier rolling balls that read the lane sooner. These products generally come factory-sanded with lower grit surfaces and match up well for speed-dominant styles and those bowling on longer oil patterns.

### 12-15

Medium-length balls that produce easier length through the midlane. Good for most house shots and medium-volume sport patterns

### 15-19+

Balls offering extra length for those bowling on lighter oil concentrations. Also beneficial for slower speed players, or those with higher rev rates needing added push downlane.

## BREAKPOINT SHAPE

### 10-13

Slower-response balls that read the friction areas more gradually. This range may include balls with a urethane or mild reactive cover, designed for a smooth arc to the pocket. Also can help those with higher rev rates control motion and match up well from outside angles of attack.

### 13-15

Balls rated for slightly stronger and quicker reactions when encountering friction areas (as when the ball leaves the oil pattern). This range offers a balance of control and back-end angularity.

### 15-18+

Balls that respond more quickly and aggressively to friction areas. This range can help those with less hand action create more angularity near the pocket. Also preferred when playing deeper inside angles, which generally require more entry angle for above-average pin carry.

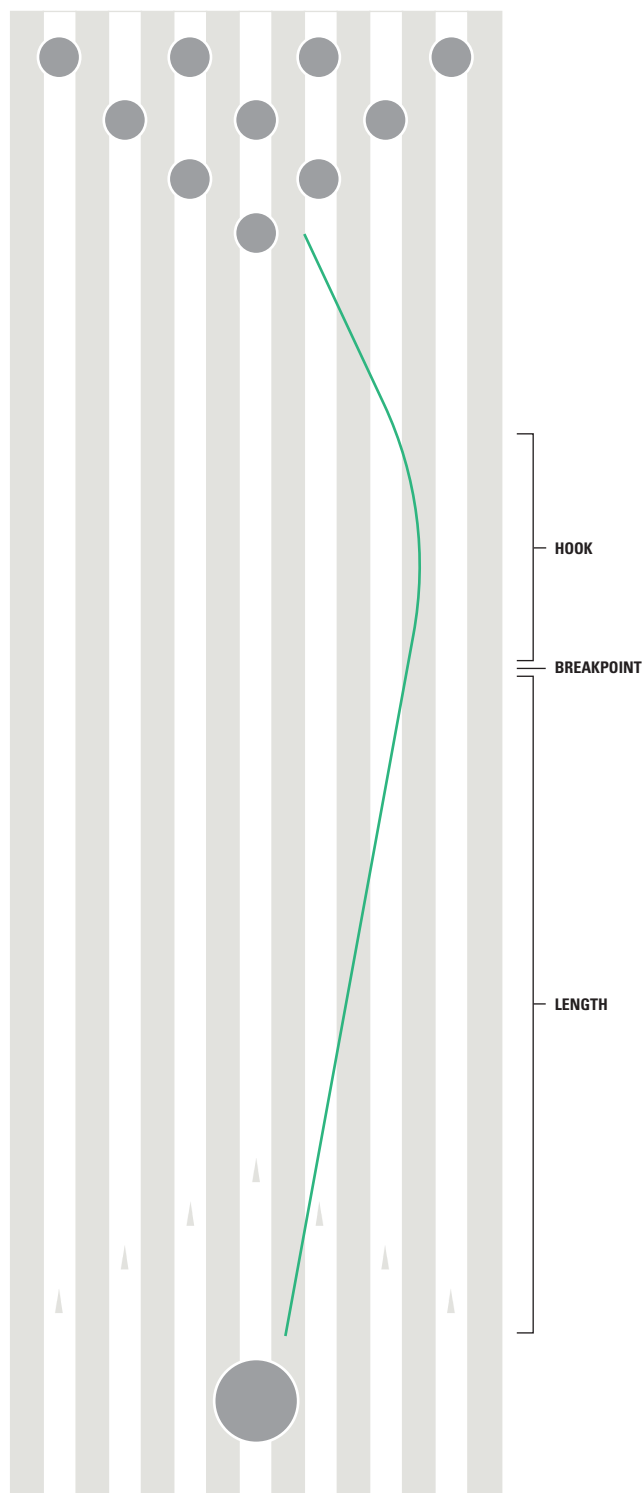

## DEFINITIONS

### HOOK

A ball moving in a curved pattern that curves sharply towards the headpin

### LENGTH

How far a ball will travel down the lane before it begins to hook towards the headpin

### BREAKPOINT

The point where the ball begins to hook towards the headpin

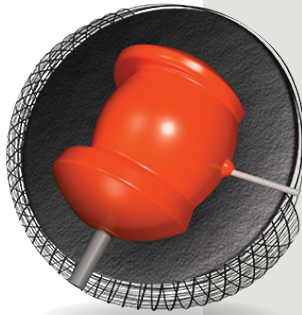

## HAMMER 3D OFFSET

March 2022

61.75 Hook ■ 15.5 Length ■ 15 Breakpoint Shape

Cover Neoflex 25 Pearl

Box Finish 500, 2000 SiaAir Micro Pads

RG 2.48 ■ RG Differential .053

**Review** It complements the Obsession Tour Solid (March 2021) and Infamous with a little cleaner motion and stronger continuation down-lane.

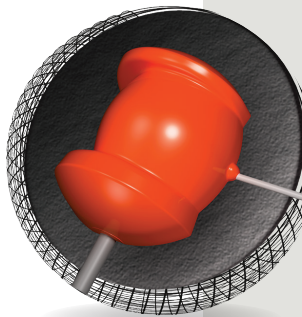

## HAMMER 3D OFFSET ATTACK

December 2022

61 Hook ■ 16 Length ■ 16.5 Breakpoint Shape

Cover HK22-Neoflip 25 Pearl

Box Finish 500, 1000, 1500 Siaair Micro Pads, Crown Factory Compound

RG 2.489 ■ RG Differential .053

**Review** The 3-D Attack is a cleaner version of the violet 3-D Offset with a stronger back-end reaction.



## ABS ACCU LINE TOUR PREMIUM 5

August 2022

61 Hook ■ 16 Length ■ 15.5 Breakpoint Shape

Cover Nano-Thane Active Hybrid Level 2

Box Finish 800 Abralon and Diamond Compound

RG 2.460 ■ RG Differential .0554

**Review** The Tour Premium 5 complements the Accu Rise 9 if you need to stay in the same zone but change your breakpoint to an earlier and stronger mid-lane motion.

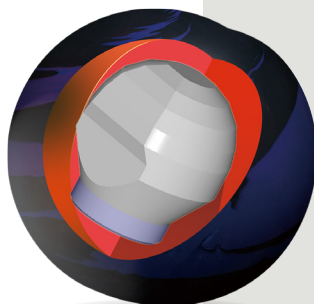

## **ABS ACCU RISE 9**

August 2022

**59 Hook** ▪ **16.5 Length** ▪ **16.5 Breakpoint Shape**

**Cover** Nano-thane 3.5 Pearl Level 3.5

**Box Finish** 500, 1500 SiaAir Micro Pads

**RG** 2.474 ▪ **RG Differential** .0541

**Review** The Accu Rise 9 is a very good ball for medium lane patterns for high-rev players with its smooth, clean push through the fronts and predictable back-end motion.

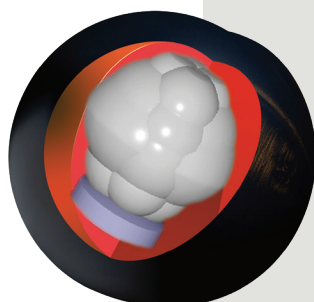

## **ABS ACCU RISE X**

December 2022

**58.5 Hook** ▪ **16.75 Length** ▪ **16.75 Breakpoint Shape**

**Cover** Nano-thane 2.0 Pearl

**Box Finish** 800 Abralon, Diamond Compound 2 Polish

**RG** 2.464 ▪ **RG Differential** .050

**Review** High-rev players will like this pearl's predictable back-end motion on medium patterns.



## **BRUNSWICK ATTITUDE**

July 2022

**60 Hook** ▪ **16 Length** ▪ **16 Breakpoint Shape**

**Cover** Activator Plus 3.0 Pearl

**Box Finish** 500, 1000, 1500 Siaair Micro Pads, Crown Factory Compound

**RG** 2.474 ▪ **RG Differential** .047

**Review** The Attitude will complement the Defender (April 2022) or the Quantum Evo Pearl if they are not clean enough and you need that skid/flip motion but with a strong symmetric core.



## BRUNSWICK ATTITUDE CONTROL

July 2022

58.5 Hook ■ 14.5 Length ■ 14.5 Breakpoint Shape

Cover Pearl Urethane

Box Finish 500, 1000 SiaAir Micro Pads

RG 2.474 ■ RG Differential .047

**Review** The Attitude Control is a true urethane ball that can shape down-lane and open up shorter patterns for even lower-rev players.



## SWAG BIG BRO BIG GUNS

December 2022

62 Hook ■ 15.5 Length ■ 16.25 Breakpoint Shape

Cover S.H.A.R.P. Pearl

Box Finish 500, 1000, 4000 Siaair Micro Pads

RG 2.480 ■ RG Differential .034

**Review** The Big Bro Big Guns brings a bigger Big Bro to the market with more hook and stronger mid-lane motion on medium to longer patterns.



## SWAG BIG BRO K.O.

April 2022

61.5 Hook ■ 15.5 Length ■ 16 Breakpoint Shape

Cover RVR4 Pearl

Box Finish 4000 Abralon

RG 2.472 ■ RG Differential .052

**Review** The Big Bro K.O. really opened our eyes with a good reaction on both patterns, creating a lot of area to the pocket and good pin action.



## **RADICAL BIGFOOT**

**April 2022**

**59 Hook** ▪ **16.5 Length** ▪ **17.25 Breakpoint Shape**

**Cover** TP-1+ Pearl

**Box Finish** 500, 1000 and 15000 Siaair Micro Pads, Crown Factory Compound

**RG** 2.468 ▪ **RG Differential** .053

**Review** The Bigfoot leaves its footprint on the lane because this ball is much more aggressive down-lane than we expected, which showed especially on our medium BJ test pattern.



## **RADICAL BIGFOOT HYBRID**

**December 2022**

**60 Hook** ▪ **16 Length** ▪ **16 Breakpoint Shape**

**Cover** Motion Magic Plus Hybrid

**Box Finish** 500, 1000, 1500 Siaair Micro Pads, Crown Factory Compound

**RG** 2.477 ▪ **RG Differential** .053

**Review** The Bigfoot Hybrid is a stronger version of the Bigfoot. This ball is versatile for various styles of players, but especially high-rev ones.

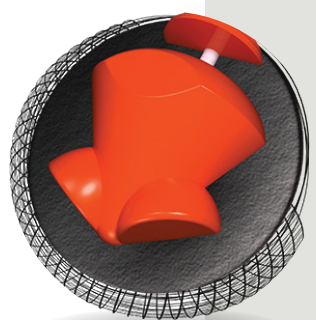

## **HAMMER BLACK WIDOW PINK PEARL**

**March 2022**

**57.5 Hook** ▪ **14 Length** ▪ **14 Breakpoint Shape**

**Cover** Urethane Pearl

**Box Finish** 360, 800 Siaair Micro Pads

**RG** 2.50 ▪ **RG Differential** .058

**Review** With our tweener rev rate we could still open up the lane a little more with the Black Widow Pink Pearl than we can with most urethanes.



### LORD FIELD BLIZZARD MELTDOWN

April 2022

62 Hook ■ 14 Length ■ 14 Breakpoint Shape

Cover Reverie 3 Pearl

Box Finish 4000 Abralon

RG 2.497 ■ RG Differential .050

**Review** The Blizzard Meltdown, with its strong asymmetric core, is easily the strongest ball we have tested in the Blizzard series.



### LORD FIELD BLIZZARD WHITEOUT

June 2022

62.5 Hook ■ 13.5 Length ■ 13.5 Breakpoint Shape

Cover Reverie 3 Pearl

Box Finish 4000 Grit Sanded

RG 2.497 ■ RG Differential .052

**Review** The Blizzard Whiteout has a strong asymmetric core that provides a strong mid-lane and predictable back-end motion.

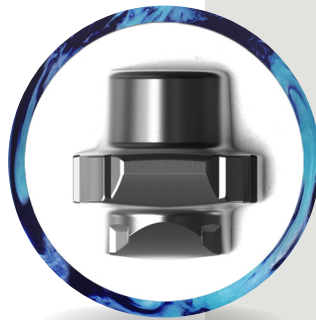

### MOTIV BLUE CORAL VENOM

May 2022

58.5 Hook ■ 16 Length ■ 16 Breakpoint Shape

Cover Coercion MFH Reactive

Box Finish 4000 Grit LSS

RG 2.47 ■ RG Differential .036

**Review** The good-looking Blue Coral Venom makes the Venom line much stronger with more overall hook.





## MOTIV BLUE TANK

June 2022

55 Hook ▪ 13 Length ▪ 15 Breakpoint Shape

Cover Frixion M3 Pearl MCP Reactive

Box Finish 1000 Grit Sanded

RG 2.59 ▪ RG Differential .023

**Review** The Blue Tank provided more hook and down-lane motion than we expected.

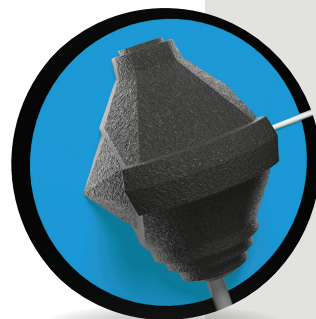

## DV8 BRUTAL COLLISION

December 2022

60.5 Hook ▪ 16 Length ▪ 16.25 Breakpoint Shape

Cover HK22-Inciter Xtreme Solid

Box Finish 500, 1000, 1500 Siaair Micro Pads

RG 2.462 ▪ RG Differential .052

**Review** The Brutal Collision is a stronger version of the Collision for medium lane patterns, with a strong, continuous down-lane motion.



## MOTIV CARBIDE TANK

December 2022

57.5 Hook ▪ 12 Length ▪ 13 Breakpoint Shape

Cover Frixion M4 Solid MCP

Box Finish 1000 LSS

RG 2.48 ▪ RG Differential .034

**Review** The Carbide Tank, which fits between true urethanes and true reactives, has a strong, heavy roll that lets lower-rev players like us open up both patterns to the right better than most urethane balls do.

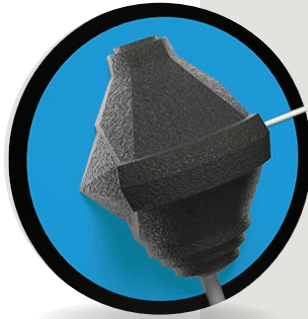

## DV8 COLLISION

March 2022

**60 Hook** ■ **16 Length** ■ **16 Breakpoint Shape**

**Cover** Inciter Max Continuation Hybrid

**Box Finish** 500, 1000 SiaAir Micro Pads, Crown Factory Compound

**RG** 2.46 ■ **RG Differential** .052

**Review** The Collision is a sharp-looking ball with an equally sharp back-end motion for medium lane conditions.

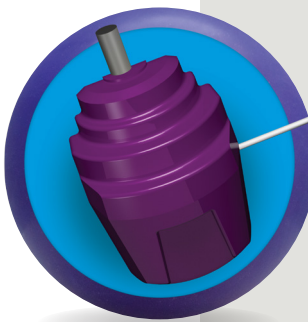

## RADICAL CONSPIRACY SCHEME

April 2022

**57 Hook** ■ **17 Length** ■ **15 Breakpoint Shape**

**Cover** Motion Magic Solid

**Box Finish** 500 Siaair Micro Pad, Crown Factory Compound

**RG** 2.487 ■ **RG Differential** .056

**Review** The Conspiracy Scheme will open up medium patterns easily with a controlled back-end reaction.

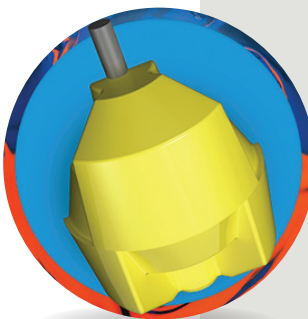

## RADICAL CRYPTO

September 2022

**62.5 Hook** ■ **15 Length** ■ **15 Breakpoint Shape**

**Cover** Ai-45 Solid

**Box Finish** 500, 2000 Siaair Micro Pads

**RG** 2.481 ■ **RG Differential** .046

**Review** Rev-deprived players will like the great value and high hook potential.



## COLUMBIA 300 CUDA POWERCOR

October 2022

63 Hook ▪ 14 Length ▪ 14 Breakpoint Shape

Cover ERT Solid

Box Finish 500, 1500 SiaAir Micro Pads

RG 2.501 ▪ RG Differential .047

**Review** Low-rev and high-rev players will like the motion and hook this ball provides.

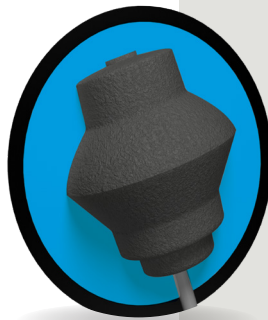

## BRUNSWICK DAMN GOOD VERGE PEARL

May 2022

58 Hook ▪ 16 Length ▪ 16 Breakpoint Shape

Cover Inciter Pearl

Box Finish 500, 1000, 1500 Siaair Micro Pads,  
Crown Factory Polish

RG 2.512 ▪ RG Differential .051

**Review** The Damn Good Verge Pearl provides skid through the fronts with a strong back-end motion when the Damn Good Verge Solid is too strong and loses energy downlane.

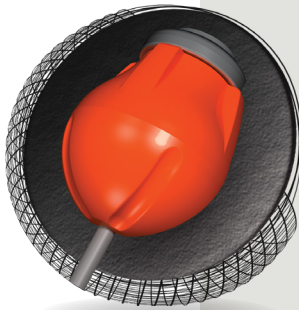

## HAMMER DARK WEB

August 2022

52.5 Hook ▪ 14 Length ▪ 14 Breakpoint Shape

Cover Aggression Solid

Box Finish 500, 1500 Siaair Micro Pads

RG 2.514 ▪ RG Differential .048

**Review** The Dark Web looks like a hook monster when it comes out of the box, but it is actually a strong, continuous benchmark ball for medium to longer patterns.

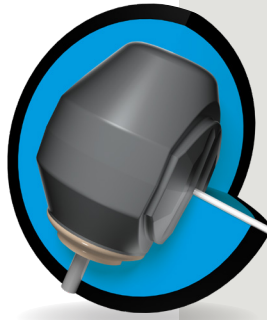

## BRUNSWICK DEFENDER

April 2022

62.5 Hook ■ 15 Length ■ 15 Breakpoint Shape

Cover ACT 3.0 Solid

Box Finish 500, 2000 Abralon

RG 2.473 ■ RG Differential .054

**Review** The Defender brings a cleaner and stronger down-lane motion through the pocket than the Zenith Solid (December 2020).



## BRUNSWICK DEFENDER HYBRID

November 2022

57.5 Hook ■ 16 Length ■ 16 Breakpoint Shape

Cover HK22-A.C.T. Hybrid

Box Finish 500, 1000, 1500 Siaair Micro Pads,  
Crown Factory Polish

RG 2.473 ■ RG Differential .054

**Review** The strong predictable motion down-lane creates a lot of forgiveness on medium patterns.



## DV8 DIAMOND DIVA

July 2022

59 Hook ■ 16.5 Length ■ 16.5 Breakpoint Shape

Cover Inciter Max Flip Hybrid

Box Finish 500, 1000, 1500 Siaair Micro Pads,  
Crown Factory Compound

RG 2.495 ■ RG Differential .051

**Review** The Diamond Diva brings the Diva line back to life with its sharp, pink colors and strong back-end motion that guys will want to throw.



## **RADICAL DOUBLE CROSS**

**February 2022**

**57 Hook** ▪ **14 Length** ▪ **14.75 Breakpoint Shape**

**Cover** U73 Pearl Urethane

**Box Finish** 500, 1500 Siaair Micro Pads

**RG** 2.528 ▪ **RG Differential** .035

**Review** The Double Cross helps the low-rev or speed-deprived bowler with more hook and hitting power than your typical urethane ball.

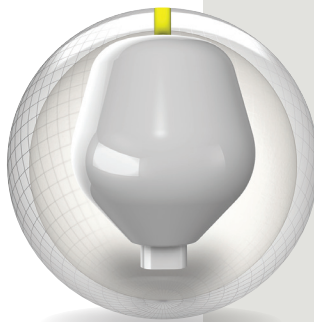

## **STORM ELECTRIFY G-O**

**November 2022**

**56.5 Hook** ▪ **16.5 Length** ▪ **16.5 Breakpoint Shape**

**Cover** Reactor Pearl

**Box Finish** Reacta Gloss

**RG** 2.51 ▪ **RG Differential** .030

**Review** This ball is a stronger version of the Electrify Pearl and a good choice for medium to hooking patterns and for later in longer blocks.

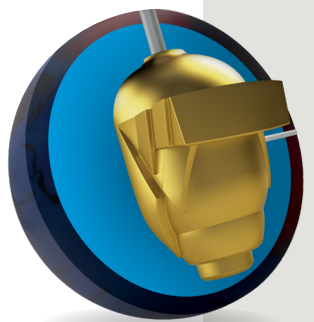

## **EBONITE ENVISION**

**May 2022**

**63 Hook** ▪ **15.5 Length** ▪ **16 Breakpoint Shape**

**Cover** GSV-X Solid

**Box Finish** 500, 2000 Siaair Micro Pads

**RG** 2.501 ▪ **RG Differential** .053

**Review** The Envision provides a cleaner motion through the heads on longer and heavier patterns than most strong solid asymmetric balls, with stronger continuation downlane.

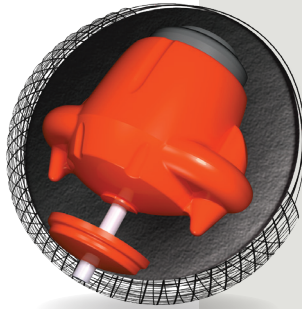

## HAMMER ENVY

October 2022

64.5 Hook ■ 14.5 Length ■ 15.5 Breakpoint Shape

Cover Envy Solid

Box Finish 500, 1500 Siaair Micro Pads

RG 2.505 ■ RG Differential .021

**Review** It takes a lot to replace the Obsession, but the Envy does and will make any low-rev player envious of those throwing it.

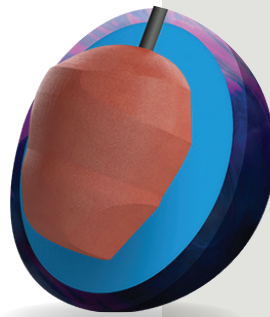

## COLUMBIA 300 ERUPTION PEARL

February 2022

60 Hook ■ 16.75 Length ■ 16.5 Breakpoint Shape

Cover Reflex Pearl

Box Finish 500, 1000, 1500 Siaair Micro Pads, Crown Factory Compound

RG 2.469 ■ RG Differential .043

**Review** The Eruption Pearl provides a clean motion through the fronts and strong backend motion, which we saw much better on the BJ test pattern.



## SWAG FANTASY DAZE

January 2022

61.5 Hook ■ 15 Length ■ 14 Breakpoint Shape

Cover Reverie 3 Solid

Box Finish 3000 Grit

RG 2.484 ■ RG Differential .044

**Review** For a symmetric ball, the Fantasy Daze creates a good amount of free, strong, mid-lane hooking motion, which tournament players will appreciate.



## STORM FATE

December 2022

58.25 Hook ▪ 17 Length ▪ 17 Breakpoint Shape

Cover ReX Pearl

Box Finish Reacta Gloss

RG 2.52 ▪ RG Differential .053

**Review** The Fate is a versatile ball for two handers or traditional bowlers on medium or drier patterns.



## MOTIV FORGE EMBER

September 2022

62.5 Hook ▪ 14.5 Length ▪ 15 Breakpoint Shape

Cover Infusion MXC Hybrid

Box Finish 2000 Grit LSS

RG 2.47 ▪ RG Differential .055

**Review** The Forge Ember brings a stronger mid-lane motion and good overall hook on medium to longer patterns to the Forge series.

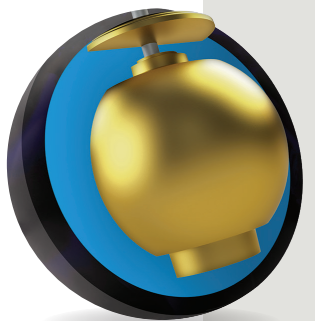

## EBONITE GB2

November 2022

63.5 Hook ▪ 15.5 Length ▪ 15.5 Breakpoint Shape

Cover GB 10.7 Solid

Box Finish 500, 1500, 3000 SiaAir Micro Pads

RG 2.480 ▪ RG Differential .048

**Review** This ball is more versatile and stronger down-lane than the GB3 (March 2018) or GB4 versions.



## EBONITE GB4 PEARL

March 2022

58.5 Hook ■ 16.5 Length ■ 16.25 Breakpoint Shape

Cover GB 12.0 Pearl

Box Finish 500, 1000, 1500 Siaair Micro Pads

RG 2.48 ■ RG Differential .048

**Review** The GB4 Pearl complements the Game Breaker Asym (August 2021) and the GB4 Solid nicely.

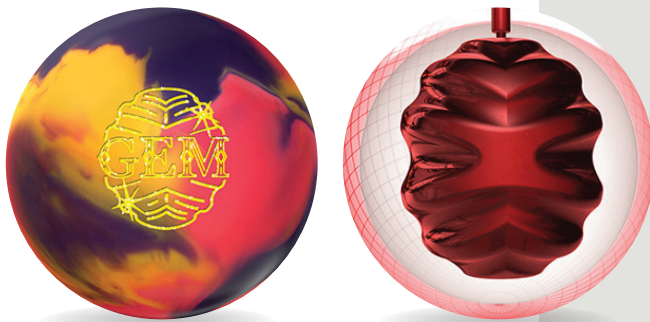

## ROTO GRIP GEM

March 2022

63.5 Hook ■ 15.5 Length ■ 16 Breakpoint Shape

Cover MicroTrax Solid

Box Finish 2000 Abralon

RG 2.47 ■ RG Differential .053

**Review** The free hook and strong mid-lane motion will help out low-rev or speed-dominant players on medium to longer patterns.

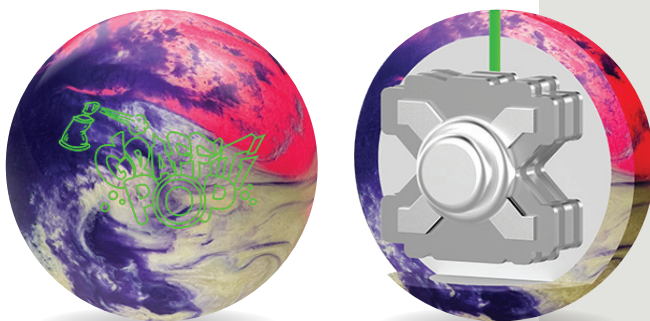

## SWAG GRAFFITI POP

January 2022

56 Hook ■ 16.5 Length ■ 16.5 Breakpoint Shape

Cover RVR4 Pearl

Box Finish 1000 Sanded, Factory Polish

RG 2.491 ■ RG Differential .053

**Review** The Graffiti Pop has a strong asymmetric core for medium lane conditions and is clean through the fronts with a strong down-lane motion.



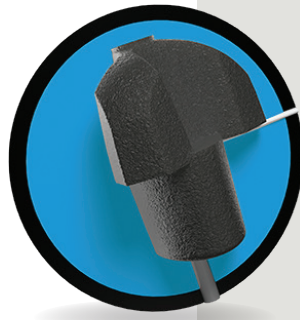

## DV8 HELLCAT

September 2022

62.75 Hook ▪ 14.5 Length ▪ 15 Breakpoint Shape

Cover Hovac Solid

Box Finish 500, 2000 SiaAir Micro Pads

RG 2.537 ▪ RG Differential .053

**Review** The Hellcat brings a big ball to the DV8 arsenal for medium to longer patterns, especially for speed-dominant or rev-deprived players.

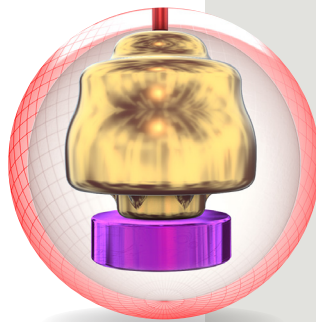

## ROTO GRIP HUSTLE USA

August 2022

59 Hook ▪ 15.5 Length ▪ 16 Breakpoint Shape

Cover VTC Hybrid

Box Finish 3000 Grit Abralon

RG 2.53 ▪ RG Differential .030

**Review** This Hustle cut through the conditioner a little easier than the shiny Hustle Wine (July 2021), but it didn't hook as much more as we thought it would by the looks.

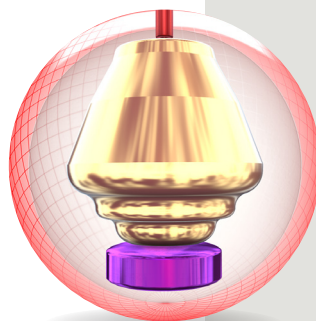

## ROTO GRIP HYPED SOLID

August 2022

61.5 Hook ▪ 16 Length ▪ 15 Breakpoint Shape

Cover VTC Solid

Box Finish 3000 Grit Abralon

RG 2.52 ▪ RG Differential .036

**Review** The Hyped Solid is a good benchmark ball for a great value. High-rev players will like the predictability and smoothness on medium patterns.

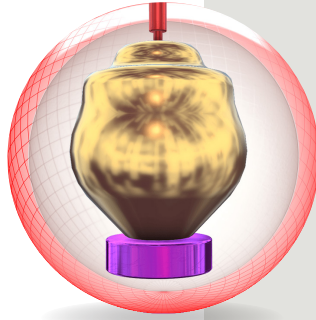

## ROTO GRIP IDOL COSMOS

July 2022

61.5 Hook ■ 15.5 Length ■ 16 Breakpoint Shape

Cover XtremeTrax Pearl

Box Finish 4000 Grit Abralon

RG 2.497 ■ RG Differential .052

**Review** The Idol Cosmos is a sharp-looking, green, symmetric ball to complement the Idol Helios and replace the Idol Pearl (not reviewed).



## STORM INFINITE PHYSIX

July 2022

64.5 Hook ■ 16 Length ■ 16.5 Breakpoint Shape

Cover ReX Pearl

Box Finish 4000 Grit Abralon

RG 2.48 ■ RG Differential .053

**Review** This ball really brings a strong but predictable back-end motion on medium to long patterns.



## RADICAL INNOVATOR

November 2022

59.5 Hook ■ 16.5 Length ■ 16.5 Breakpoint Shape

Cover Motion Magic Plus

Box Finish 500, 1000, 1500 Siaair Micro Pads, Crown Factory Compound

RG 2.477 ■ RG Differential .053

**Review** Mo Pinel's big core technology was evident in the Innovator's strong reaction.



## TRACK KINETIC BLACK ICE

May 2022

57 Hook ▪ 17 Length ▪ 17 Breakpoint Shape

Cover QR-7 Pearl

Box Finish 500, 1000, 1500 SiaAir Micro Pads,  
Crown Factory Compound

RG 2.480 ▪ RG Differential .040

Review The Kinetic Black Ice is an asymmetric  
pearl ball for medium to dry lane patterns.



## BRUNSWICK KNOCK OUT BLACK AND BLUE

February 2022

62 Hook ▪ 15.5 Length ▪ 15.5 Breakpoint Shape

Cover Savvy Hook 3.5 Solid

Box Finish 500, 2000 Siaair Micro Pads

RG 2.487 ▪ RG Differential .050

Review This ball opens up medium patterns  
more easily than the original for lower-rev and  
speed-dominant players.

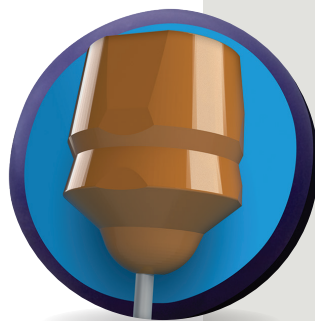

## TRACK LEGION SOLID

November 2022

64.75 Hook ▪ 15 Length ▪ 15 Breakpoint Shape

Cover Prime Response

Box Finish 500, 2000 Siaair Micro Pads

RG 2.500 ▪ RG Differential .046

Review The Legion Solid provides free hook for  
a great value for speed-dominant or rev-deprived  
players.



## BRUNSWICK MELEE JAB CARBON

September 2022

57 Hook ■ 16.75 Length ■ 17.5 Breakpoint Shape

Cover A.X.H. Pearl

Box Finish 500, 1000, 1500 Siaair Micro Pads,  
Crown Factory Compounds

RG 2.487 ■ RG Differential .050

**Review** The Carbon brings a cleaner and stronger back-end reaction to the Melee Jab line for medium to drier conditions.

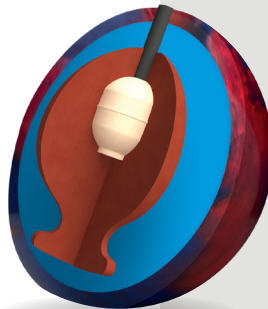

## COLUMBIA 300 MESSENGER POWERCOR PEARL

August 2022

53.5 Hook ■ 17 Length ■ 16 Breakpoint Shape

Cover Reflex Pearl

Box Finish 500, 1000, 2000 SiaAir Micro Pads,  
Crown Factory Compound

RG 2.515 ■ RG Differential .040

**Review** The Messenger Pearl is a stronger version of the Beast line with very strong hitting power.

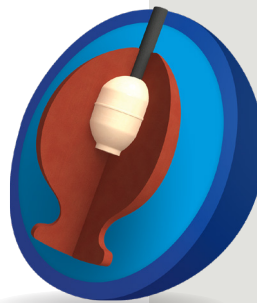

## COLUMBIA 300 MESSENGER POWERCOR SOLID

August 2022

61 Hook ■ 15 Length ■ 15 Breakpoint Shape

Cover Reflex Solid

Box Finish 500, 1500, 3000 Siaair Micro Pads

RG 2.515 ■ RG Differential .040

**Review** The Messenger Solid provided more hook than we expected but was very smooth and predictable.



## MOTIV MYTHIC JACKAL

February 2022

59 Hook ▪ 16.75 Length ▪ 17 Breakpoint Shape

Cover Infusion HV Hybrid

Box Finish 5000 Grit LSP

RG 2.47 ▪ RG Differential .054

**Review** The Mythic Jackal brings a stronger asymmetric pearl than Jackal Flash (November 2020) to the Jackal line.

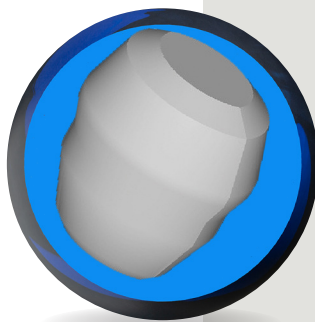

## ABS NANODESU GRASP TOUR EDITION

August 2022

63 Hook ▪ 13.5 Length ▪ 14 Breakpoint Shape

Cover Nano-thane 4.0 Pearl Level 4.0

Box Finish 1000 Abralon

RG 2.501 ▪ RG Differential .045

**Review** The Nanodesu Grasp Tour Edition is a very strong asymmetric ball that reads the midlane strongly with very heavy roll through the pocket on longer to heavier lane patterns.

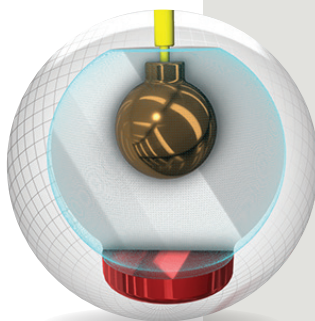

## STORM NIGHT ROAD

September 2022

61 Hook ▪ 16.5 Length ▪ 16.5 Breakpoint Shape

Cover ReX Pearl

Box Finish 4K-Fast

RG 2.57 ▪ RG Differential .046

**Review** The famous Hy-Road line's core gives the Night Road its strong push through the fronts and strong back-end motion to create a strong pin carry.

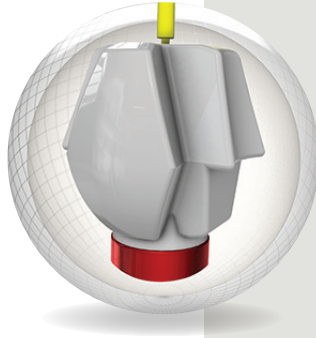

## STORM NOVA

January 2022

63.5 Hook ■ 15.5 Length ■ 16 Breakpoint Shape

Cover R2X Hybrid

Box Finish 3000 Grit Sanded

RG 2.49 ■ RG Differential .052

**Review** The Nova is one of the strongest hooking balls we have seen in the Storm line, but it isn't your "Hook early and bail down the lane" kind of ball.

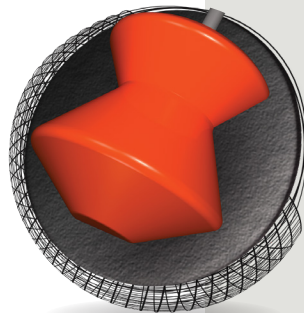

## HAMMER OCEAN VIBE

August 2022

54 Hook ■ 16.5 Length ■ 16.5 Breakpoint Shape

Cover CT Reactive Plus

Box Finish 500, 1000, 2000 Siaair Micro Pads, Crown Factory Polish

RG 2.510 ■ RG Differential .042

**Review** The Vibe complements the Infamous and Scorpion (both September 2021) nicely when the fronts of the lanes start to go and you need that strong, clean push through the heads and strong back-end reaction.

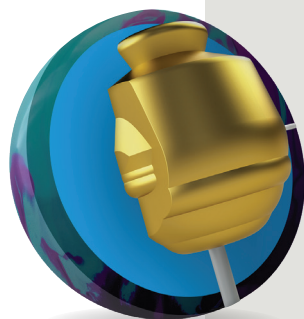

## EBONITE THE ONE REMIX

October 2022

57.5 Hook ■ 16.25 Length ■ 16 Breakpoint Shape

Cover A.X.H. Pearl

Box Finish 500, 1000, 1500 Siaair Micro Pads, Crown Factory Compound

RG 2.466 ■ RG Differential .056

**Review** The One Remix looks and reacts similar to the original One, which we loved and sold a lot of.

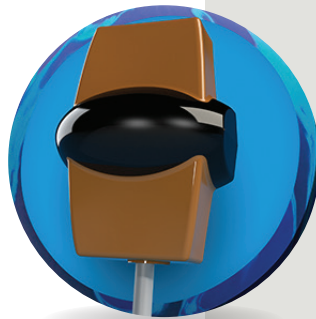

## TRACK PARAGON

February 2022

64.5 Hook ▪ 15 Length ▪ 15 Breakpoint Shape

Cover QR-11 Solid

Box Finish 500 Siaair Micro Pad

RG 2.486 ▪ RG Differential .056

**Review** The Paragon is a ball for low-rev and speed-dominant players on longer and heavier patterns.

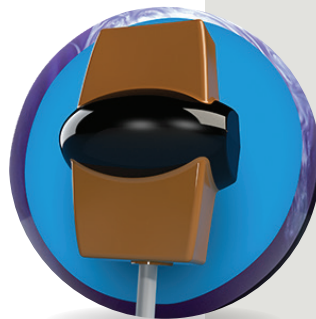

## TRACK PARAGON HYBRID

September 2022

59.5 Hook ▪ 16.5 Length ▪ 16 Breakpoint Shape

Cover QR-11 Hybrid

Box Finish 500, 1000, 1500 Siaair Micro Pads, Crown Factory Compound

RG 2.489 ▪ RG Differential .054

**Review** The Paragon Hybrid is a good ball when the fronts start to go, as well as for those with slower ball speeds who need some free hook on medium patterns.

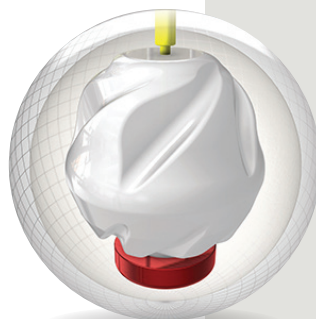

## STORM PHAZE 4

February 2022

59 Hook ▪ 16.5 Length ▪ 17 Breakpoint Shape

Cover R2S Pearl

Box Finish 1500 Grit Polish

RG 2.48 ▪ RG Differential .051

**Review** The Phaze 4 has the strongest back-end reaction we have seen from Phaze balls.

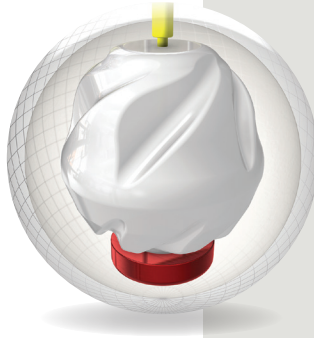

## STORM PHAZE V

October 2022

59.25 Hook ■ 16.25 Length ■ 17 Breakpoint Shape

Cover R2S Pearl

Box Finish Reacta Gloss

RG 2.650 ■ RG Differential .015

**Review** The Phaze V brings back the strong pearl back-end reaction of the Phaze line with the same R2S pearl coverstock the Phaze 4 (February 2022) had.

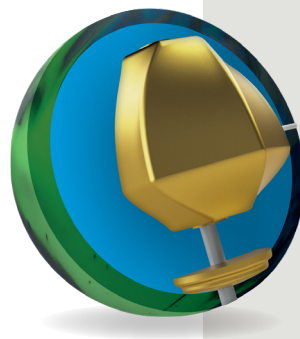

## EBONITE POLARIS HYBRID

August 2022

61 Hook ■ 16 Length ■ 16 Breakpoint Shape

Cover GSV-3 Hybrid

Box Finish 500, 1500, 3000 Siaair Micro Pads

RG 2.475 ■ RG Differential .048

**Review** The Polaris Hybrid is a forgiving strong asymmetric number two ball that rev-dominant and other players will want in their arsenals on medium to longer patterns when the patterns start to burn up or open up.

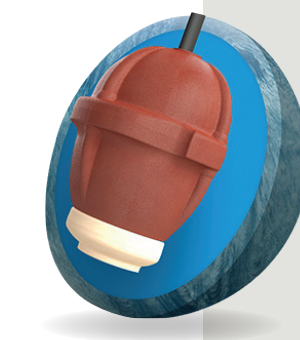

## COLUMBIA 300 POWER TORQ PEARL

June 2022

53.5 Hook ■ 15.5 Length ■ 16.5 Breakpoint Shape

Cover ERT Pearl

Box Finish 500, 1000, 1500 Siaair Micro Pads, Crown Factory Compound

RG 2.489 ■ RG Differential .054

**Review** The Power Torq Pearl complements the original solid remake of the Power Torq.





## MOTIV PRIDE EMPIRE

August 2022

57.5 Hook ▪ 17 Length ▪ 17 Breakpoint Shape

Cover Propulsion Pearl

Box Finish 5000 Grit LSP

RG 2.50 ▪ RG Differential .042

**Review** The Pride Empire provides a cleaner and stronger back-end motion than the original Pride (October 2021) for medium volume and length patterns.

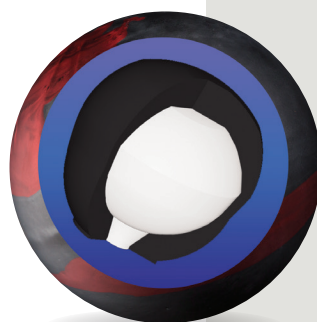

## ABS PURE RISE 74D EIGHT

December 2022

55 Hook ▪ 12 Length ▪ 12 Breakpoint Shape

Cover Low Crosslink Urethane with Nano/Fullerene

Box Finish 1000 Abralon

RG 2.570 ▪ RG Differential .052

**Review** The Pure Rise 74D Eight is one of the hardest hitting urethane balls we have seen. It works especially well for low-rev players on medium to short patterns.

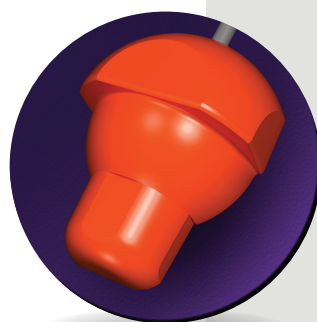

## HAMMER PURPLE HAMMER REACTIVE

December 2022

62.5 Hook ▪ 15.5 Length ▪ 16 Breakpoint Shape

Cover Solid

Box Finish 500, 1500 Siaair Micro Pads

RG 2.568 ▪ RG Differential .027

**Review** On medium to drier patterns, this ball does comparatively provide a reaction typical of reactive equipment.



## BRUNSWICK QUANTUM EVO HYBRID

September 2022

62 Hook ▪ 16 Length ▪ 16 Breakpoint Shape

Cover Evolution

Box Finish 500, 2000 Siaair Micro Pads

RG 2.510 ▪ RG Differential .051

**Review** The Quantum EVO Hybrid does what a hybrid should do: Read the midlane stronger and earlier than the pearl but not as strong or early as the solid.



## RADICAL RATTLER

November 2022

61 Hook ▪ 15 Length ▪ 15 Breakpoint Shape

Cover S.H.A.R.P.

Box Finish 1500 Grit Polish

RG 2.480 ▪ RG Differential .035

**Review** The Rattler ups the benchmark ball bar for Radical. It's a medium ball for medium patterns.



## 900 GLOBAL REALITY CHECK

August 2022

62 Hook ▪ 16 Length ▪ 16 Breakpoint Shape

Cover S84 Hybrid

Box Finish 4k Factory Finish

RG 2.49 ▪ RG Differential .052

**Review** For a ball with strong asymmetric core, it's versatile on medium to longer patterns.



## MOTIV RIPCORD LAUNCH

December 2022

57 Hook ▪ 16 Length ▪ 17.5 Breakpoint Shape

Cover Propulsion MVP Pearl

Box Finish 45500 LSP

RG 2.51 ▪ RG Differential .048

**Review** This ball really complements the Trident Odyssey (January 2022) with the strong backend and cleaner push through the fronts when the Odyssey is too early and loses energy down-lane.

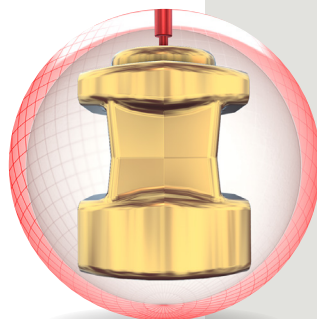

## ROTO GRIP RST X-3

August 2022

62.25 Hook ▪ 16 Length ▪ 16 Breakpoint Shape

Cover Micro Trax Hybrid

Box Finish 4k Factory Finish

RG 2.53 ▪ RG Differential .053

**Review** The RST X-3 has a little cleaner motion through the fronts and stronger back-end reaction.

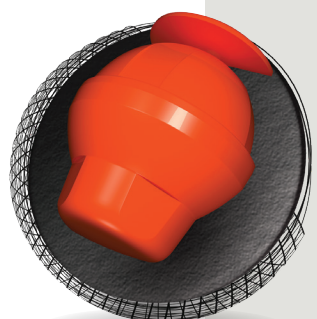

## HAMMER SCORPION STING

October 2022

58.5 Hook ▪ 16.75 Length ▪ 16.5 Breakpoint Shape

Cover Syntex Pearl

Box Finish 500, 1000, 1500 Siaair Micro Pads, Crown Factory Compound

RG 2.485 ▪ RG Differential .045

**Review** If you want a longer and stronger Scorpion that bites harder in the backend, then the Scorpion Sting is it.



## TRACK SENSOR PEARL

December 2022

55 Hook ▪ 17 Length ▪ 17 Breakpoint Shape

Cover DR-6 Pearl

Box Finish 500, 1000, 1500 Siaair Micro Pads,  
Crown Factory Compound

RG 2.490 ▪ RG Differential .034

**Review** This Sensor provides that good motion on drier patterns with a clean push through the fronts and strong motion through the pocket.

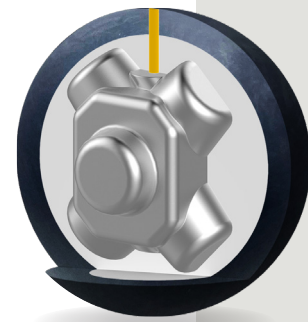

## SWAG SHOW ME THE MONEY BLACK

April 2022

62.5 Hook ▪ 14.5 Length ▪ 14 Breakpoint Shape

Cover USY2 Pearl

Box Finish 3000 Abralon

RG 2.51 ▪ RG Differential .052

**Review** Show Me the Money Black brings a strong early heavy rolling motion and predictable backend that is good on medium to long patterns.



## MOTIV SKY RAPTOR

November 2022

58 Hook ▪ 17 Length ▪ 17 Breakpoint Shape

Cover Dynamic Infusion Pearl

Box Finish 5000 Grit LSS

RG 2.48 ▪ RG Differential .055

**Review** The Sky Raptor brings a stronger down-lane motion for the MOTIV line on medium to longer patterns.



## **RADICAL SNEAK ATTACK**

June 2022

52 Hook ▪ 17 Length ▪ 17 Breakpoint Shape

Cover MTH-1 Hybrid

Box Finish 500, 1000, 2000 Siaair Micro Pads,  
Crown Factory Polish

RG 2.544 ▪ RG Differential .036

**Review** The Sneak Attack has a slick, sharp, black pearl look that does provide a sneak attack on the pins with its strong back-end reaction.

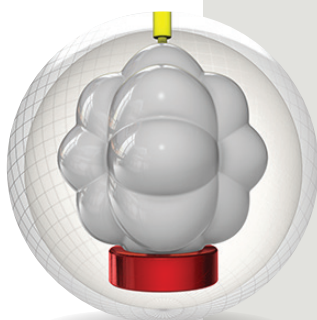

## **STORM SPECTRE**

January 2022

57.5 Hook ▪ 16.5 Length ▪ 17 Breakpoint Shape

Cover R3S Pearl

Box Finish 1500 Grit Polish

RG 2.54 ▪ RG Differential .050

**Review** The Spectre brings a clean, easy push through the fronts with a strong, continuous back-end motion on medium to hooking patterns.

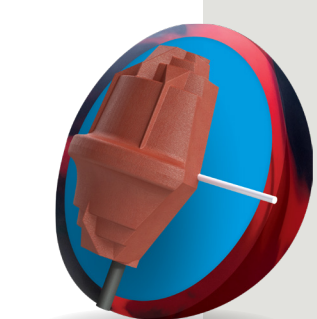

## **COLUMBIA 300 SPEED**

April 2022

64.5 Hook ▪ 14 Length ▪ 14 Breakpoint Shape

Cover Formula 1 Solid

Box Finish 2000 Abralon

RG 2.47 ▪ RG Differential .053

**Review** The Speed brings more hook than we have seen from Columbia 300 without hooking early and losing energy down-lane.



## TRACK STEALTH

July 2022

64.75 Hook ■ 15.5 Length ■ 15.25 Breakpoint Shape

Cover QR-9 Solid

Box Finish 500, 1000, 1500 Siaair Micro Pads

RG 2.482 ■ RG Differential .056

**Review** The Stealth brings a strong, continuous hook on medium to heavier and longer patterns.

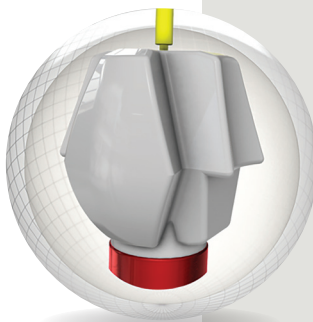

## STORM SUPER NOVA

October 2022

64.75 Hook ■ 15.25 Length ■ 15.5 Breakpoint Shape

Cover NeX Solid

Box Finish 2000 Abralon

RG 2.49 ■ RG Differential .052

**Review** The Super Nova really can open up those longer patterns much more easily than the Nova or the Proton Physix.



## SWAG SWAGGER SHOWOFF

June 2022

60.5 Hook ■ 16 Length ■ 16 Breakpoint Shape

Cover Bragger 1 Pearl

Box Finish 3000 Grit Sanded

RG 2.572 ■ RG Differential .045

**Review** For a symmetric, matte-finish ball, the Swagger Showoff brings a smooth roll through the fronts and strong continuation down-lane through the pocket.

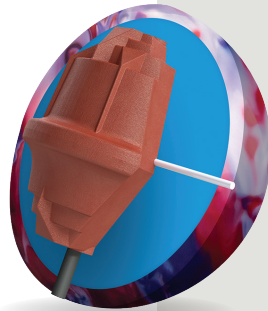

## COLUMBIA 300 TOP SPEED

November 2022

59.5 Hook ▪ 16.5 Length ▪ 16.5 Breakpoint Shape

Cover Formula 1 Pearl

Box Finish 500, 1000, 1500 Siaair Micro Pads,  
Crown Factory Compound

RG 2.478 ▪ RG Differential .050

**Review** This ball does that special thing for a pearl: It avoids wet/dry issues and isn't too angular to the pocket.

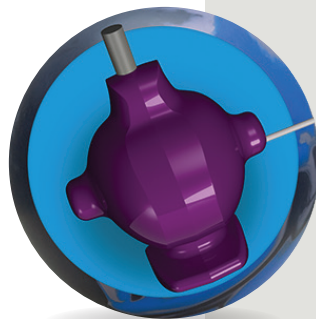

## RADICAL TRAIL BLAZER SOLID

September 2022

64.5 Hook ▪ 14.5 Length ▪ 15 Breakpoint Shape

Cover Motion Magic Solid

Box Finish 500, 2000 Siaair Micro Pads

RG 2.484 ▪ RG Differential .052

**Review** The Trail Blazer Solid needs medium to longer patterns with high volume. The Hybrid is the go-to ball when the Solid is too much hook or starts to lose its energy at the backend.

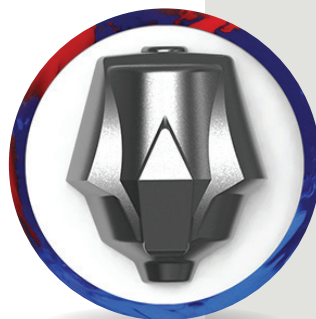

## MOTIV TRIDENT ODYSSEY

January 2022

61.5 Hook ▪ 15.5 Length ▪ 15.5 Breakpoint Shape

Cover Coersion FYS Solid

Box Finish 2000 Grit LSS

RG 2.49 ▪ RG Differential .054

**Review** The Trident Odyssey doesn't start at your toes, but it reads the midlane clean with a strong overall down-lane predictable motion.

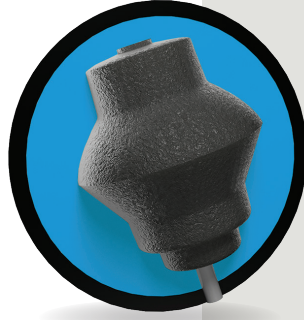

## DV8 VERGE SOLID

November 2022

65 Hook ■ 14.5 Length ■ 15 Breakpoint Shape

Cover Inciter Max Traction Solid

Box Finish 500, 1000, 1500 Siaair Micro Pads

RG 2.476 ■ RG Differential .049

**Review** Speed-dominant or rev-deprived players will really like the Verge Solid for longer patterns.



## 900 GLOBAL WOLVERINE DARK MOSS

August 2022

61 Hook ■ 16.5 Length ■ 16.5 Breakpoint Shape

Cover S70 Pearl

Box Finish 4k Factory Finish

RG 2.45 ■ RG Differential .053

**Review** The Wolverine Dark Moss is the 4k hybrid surface version of the Wolverine.



## 900 GLOBAL ZEN SOUL

June 2022

63 Hook ■ 16 Length ■ 16 Breakpoint Shape

Cover QS77 Response Hybrid

Box Finish 4000 Grit Sanded

RG 2.49 ■ RG Differential .051

**Review** The Zen Soul provides the reaction you would think, after throwing the original Zen (January 2021), that a sanded or matte-finish Zen would have.



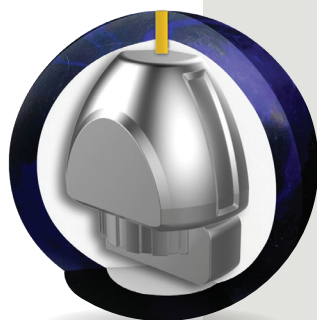

## 900 GLOBAL ZEN U

December 2022

57 Hook ■ 13 Length ■ 13 Breakpoint Shape

Cover Meditate LD

Box Finish 1000 Abralon

RG 2.56 ■ RG Differential .027

**Review** The Zen U brings the successful Zen core to the urethane market but this urethane ball allows the bowler to open up their angles with recovery to the right.

## Directory

*This list includes companies that participated in the 2022 BJI Ball Reviews.*

### 900 GLOBAL

165 S. 800 W.  
Brigham City, UT 84302  
**Phone** 888-821-2695  
900global.com  
info@900global.com

### COLUMBIA 300

525 W. Laketon Ave.  
Muskegon, MI 49441  
**Phone** 1-800-937-2695  
columbia300.com  
info@columbia300.com

### ROTO GRIP

165 S. 800 W.  
Brigham City, UT 84302  
**Phone** 435-723-9640  
or 888-450-6920  
chriss@rotogrip.com  
rotogrip.com

### ABS INTERNATIONAL

1-1-1 Kita-Magome Ohta-ku  
143-0021 Tokyo, Japan  
**Phone** +81-3-5718-7121  
jeremy@absbowling.co.jp  
abs300.com

### DV8

525 W. Laketon Ave.  
Muskegon, MI 49441  
**Phone** 1-800-937-3695  
info@dv8bowling.com  
dv8bowling.com

### HAMMER

525 W. Laketon Ave.  
Muskegon, MI 49441  
**Phone** 1-800-937-3695  
info@hammerbowling.com  
hammerbowling.com

### STORM BOWLING

165 S. 800 W.  
Brigham City, UT 84302  
**Phone** 435-723-0403  
or 800-369-4402  
info@stormbowling.com  
stormbowling.com

### BRUNSWICK

525 W. Laketon Ave.  
Muskegon, MI 49441  
**Phone** 1-800-937-3695  
consumerproducts@brunswickbowling.com  
brunswickbowling.com

### EBONITE

525 W. Laketon Ave.  
Muskegon, MI 49441  
**Phone** 1-800-937-3695  
info@ebonite.com  
ebonite.com

### MOTIV BOWLING

18570 Trimble Ct.  
Spring Lake, MI 49456  
**Phone** 616-850-9868  
or 800-235-8324  
service@motivbowling.com  
motivbowling.com

### SWAG

523 Beverly Dr.  
Wichita Falls, TX 76309  
**Phone** 940-500-4037  
info@californiabowlingllc.com  
californiabowlingllc.com

### RADICAL BOWLING

5005 W. Ave.  
San Antonio, TX 78213  
**Phone** 866-828-7702  
info@radicalbowling.com  
radicalbowling.com

### TRACK BOWLING

525 W. Laketon Ave.  
Muskegon, MI 49441  
**Phone** 1-800-937-3695  
info@trackbowling.com  
trackbowling.com

### LORD FIELD

523 Beverly Dr.  
Wichita Falls, TX 76309  
**Phone** 940-500-4037  
info@californiabowlingllc.com  
californiabowlingllc.com